



2020  
2021

Katalog | Preisliste  
Catalog | price list



# WENDEPLATTEN CUTTING INSERT



WENDESCHNEIDPLATTEN / FRÄSEN Cutting insert / milling	FÜR MATERIAL For material	Lager Stock	Preis € Price €
APMT060208PDSR	MM PC3545 Stahl/Edelstahl	■	12,20
APKT1003 PDSR ER30	Stahl/Edelstahl - Steel / stainless steel	■	07,90
APKT100304-76 ER30	Stahl/Edelstahl - Steel / stainless steel	■	07,90
APKT100308-76 ER30	Stahl/Edelstahl - Steel / stainless steel	■	07,90
APKT1003PDFR AL10	Alu/Kunststoffe - Alu/ Plastics	■	07,90
APKT1604PDSR ER30	Stahl/Edelstahl - Steel / stainless steel	■	08,90
APKT1604PDSR - 76 ER30	Stahl/Edelstahl - Steel / stainless steel	■	08,90
APKT1604PDFR AL10	Alu/Kunststoffe - Alu/ Plastics	■	08,90
XNMX080608MG ER21NS	Stahl/Guss - Steel/cast iron	■	11,90
XNMX080608RG ER41NS	Edelstahl - stainless steel	■	11,90
E390-11T308MG ER21NS	Stahl/Guss - Steel/cast iron	■	09,90
E390-11T308MG ER41NS	Stahl - Steel	■	09,90
HFMP0603RM ER30	Stahl/Edelstahl - Steel / stainless steel	■	09,90
HFMP0603MG ER32HS	Stahl/Edelstahl - Steel / stainless steel	■	09,90
LNMX0303MG ER30	Stahl/Edelstahl - Steel / stainless steel	■	09,90
GRIP4004Y ER300	Stahl/Edelstahl - Steel / stainless steel	■	13,90
TDJ3 ER300	Stahl/Edelstahl - Steel / stainless steel	■	13,90
GTN3 P35C	Stahl/Edelstahl - Steel / stainless steel	■	09,90

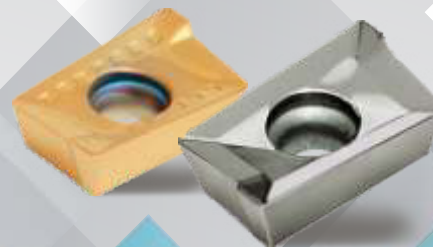

# WENDEPLATTEN / DREHEN

## CUTTING INSERT / TURNING



WENDESCHNEIDPLATTEN / DREHEN Cutting insert / turning		FÜR MATERIAL For material	Lager Stock	Preis € Price €
CCGT 060202-AF	ER100	Alu/Kunststoffe - Alu/ Plastics	■	05,90
CCGT 060204-AF	ER100	Alu/Kunststoffe - Alu/ Plastics	■	05,90
CCGT 09T302-AF	ER100	Alu/Kunststoffe - Alu/ Plastics	■	06,90
CCGT 09T304-AF	ER100	Alu/Kunststoffe - Alu/ Plastics	■	06,90
CCGT 09T308-AF	ER100	Alu/Kunststoffe - Alu/ Plastics	■	06,90
CCGT 120404-AF	ER100	Alu/Kunststoffe - Alu/ Plastics	■	06,90
CCGT 120408-AF	ER100	Alu/Kunststoffe - Alu/ Plastics	■	07,40
DCGT 070202-AF	ER100	Alu/Kunststoffe - Alu/ Plastics	■	06,40
DCGT 070204-AF	ER100	Alu/Kunststoffe - Alu/ Plastics	■	06,40
DCGT 11T302-AF	ER100	Alu/Kunststoffe - Alu/ Plastics	■	07,40
DCGT 11T304-AF	ER100	Alu/Kunststoffe - Alu/ Plastics	■	07,40
DCGT 11T308-AF	ER100	Alu/Kunststoffe - Alu/ Plastics	■	07,40
TCGT 090204-AF	ER100	Alu/Kunststoffe - Alu/ Plastics	■	06,40
TCGT 110204-AF	ER100	Alu/Kunststoffe - Alu/ Plastics	■	07,40
TCGT 110208-AF	ER100	Alu/Kunststoffe - Alu/ Plastics	■	07,40
TCGT 16T304-AF	ER100	Alu/Kunststoffe - Alu/ Plastics	■	07,40
TCGT 16T308-AF	ER100	Alu/Kunststoffe - Alu/ Plastics	■	07,40

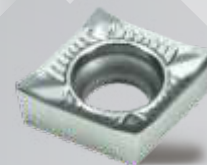

# WENDEPLATTEN / DREHEN

## CUTTING INSERT / TURNING



WENDESCHNEIDPLATTEN / DREHEN Cutting insert / turning	FÜR MATERIAL For material	Lager Stock	Preis € Price €
VCGT 110302-AF Er100	Alu/Kunststoffe - Alu/ Plastics	■	07,90
VCGT 110304-AF Er100	Alu/Kunststoffe - Alu/ Plastics	■	07,90
VCGT 110308-AF Er100	Alu/Kunststoffe - Alu/ Plastics	■	07,90
VCGT 130302-AF Er100	Alu/Kunststoffe - Alu/ Plastics	■	08,90
VCGT 130304-AF Er100	Alu/Kunststoffe - Alu/ Plastics	■	08,90
VCGT 160402-AF Er100	Alu/Kunststoffe - Alu/ Plastics	■	09,90
VCGT 160404-AF Er100	Alu/Kunststoffe - Alu/ Plastics	■	09,90
VCGT 160408-AF Er100	Alu/Kunststoffe - Alu/ Plastics	■	09,90
CNGG 120408-AF Er100	Alu/Kunststoffe - Alu/ Plastics	■	05,90
DNGG 150608-AF Er100	Alu/Kunststoffe - Alu/ Plastics	■	09,90
TNGG 160408-AF Er100	Alu/Kunststoffe - Alu/ Plastics	■	09,90
VNGG 160408-AF Er100	Alu/Kunststoffe - Alu/ Plastics	■	09,90
WNGG 080408-AF Er100	Alu/Kunststoffe - Alu/ Plastics	■	07,90

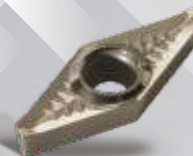

# WENDEPLATTEN / DREHEN

## CUTTING INSERT / TURNING



WENDESCHNEIDPLATTEN / DREHEN Cutting insert / turning	FÜR MATERIAL For material	Lager Stock	Preis € Price €
CNMG 120404-FP ER300	Stahl - Steel	■	06,90
CNMG 120408-FP ER300	Stahl - Steel	■	06,90
CNMG 120408-MP ER320	Stahl - Steel	■	06,90
CNMG 120412-RP ER335	Stahl - Steel	■	06,90
CNMM 120412-RP ER335	Stahl - Steel	■	06,90
CNMG 160612-RP ER335	Stahl - Steel	■	09,90
DNMG 110404-FP ER300	Stahl - Steel	■	06,90
DNMG 110408-FP ER300	Stahl - Steel	■	06,90
DNMG 110408-MP ER320	Stahl - Steel	■	06,90
DNMG 150604-FP ER300	Stahl - Steel	■	08,90
DNMG 150608-FP ER300	Stahl - Steel	■	08,90
DNMG 150608-MP ER320	Stahl - Steel	■	08,90
DNMG 150608-RP ER335	Stahl - Steel	■	08,90



Bezeichnung Geometrie Bearbeitung / Geometry processing application  
 FP= Feinbearbeitung schlichten Stahl / finishing steel  
 MP= Mittlere Bearbeitung Stahl, Edelstahl / medium steel, stainless steel  
 RP= Schrupp Bearbeitung Stahl, Edelstahl / roughing steel, stainless steel

# WENDEPLATTEN / DREHEN

## CUTTING INSERT / TURNING



WENDESCHNEIDPLATTEN / DREHEN Cutting insert / turning		FÜR MATERIAL For material	Lager Stock	Preis € Price €
CCMT 060202-FP	ER300	Stahl - Steel	■	04,95
CCMT 060204-FP	ER300	Stahl - Steel	■	04,95
CCMT 060204-MP	ER320	Stahl - Steel	■	04,95
CCMT 09T302-FP	ER300	Stahl - Steel	■	05,95
CCMT 09T304-FP	ER300	Stahl - Steel	■	05,95
CCMT 09T304-MP	ER320	Stahl - Steel	■	05,95
CCMT 09T308-MP	ER320	Stahl - Steel	■	05,95
CCMT 120408-MP	ER320	Stahl - Steel	■	06,95
DCMT 070202-FP	ER300	Stahl - Steel	■	04,95
DCMT 070204-FP	ER300	Stahl - Steel	■	04,95
DCMT 11T302-FP	ER300	Stahl - Steel	■	05,95
DCMT 11T304-FP	ER300	Stahl - Steel	■	05,95

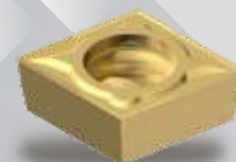

Bezeichnung Geometrie Bearbeitung / Geometry processing application  
 FP= Feinbearbeitung schlichten Stahl / finishing steel  
 MP= Mittlere Bearbeitung Stahl, Edelstahl / medium steel, stainless steel  
 RP= Schrupp Bearbeitung Stahl, Edelstahl / roughing steel, stainless steel

# WENDEPLATTEN / DREHEN

## CUTTING INSERT / TURNING



WENDESCHNEIDPLATTEN / DREHEN Cutting insert / turning	FÜR MATERIAL For material	Lager Stock	Preis € Price €
VBMT 110302-FP ER300	Stahl - Steel	■	06,90
VBMT 110304-FP ER300	Stahl - Steel	■	06,90
VCMT 110304-FP ER300	Stahl - Steel	■	06,90
VCMT 16T304-FP ER300	Stahl - Steel	■	08,90
VCMT 16T304-MP ER320	Stahl - Steel	■	08,90
VCMT 16T308-MP ER320	Stahl - Steel	■	08,90
VNMG 160404-FP ER300	Stahl - Steel	■	09,90
VNMG 160408-FP ER300	Stahl - Steel	■	09,90
VNMG 160408-MP ER320	Stahl - Steel	■	09,90
TNMG 160404-FP ER300	Stahl - Steel	■	05,95
TNMG 160408-MP ER320	Stahl - Steel	■	05,95



Bezeichnung Geometrie Bearbeitung / Geometry processing application  
 FP= Feinbearbeitung schlichten Stahl / finishing steel  
 MP= Mittlere Bearbeitung Stahl, Edelstahl / medium steel, stainless steel  
 RP= Schrapp Bearbeitung Stahl, Edelstahl / roughing steel, stainless steel

# WENDEPLATTEN / DREHEN

## CUTTING INSERT / TURNING



WENDESCHNEIDPLATTEN / DREHEN Cutting insert / turning	FÜR MATERIAL For material	Lager Stock	Preis € Price €
TCMT 110204-PF ER300	Stahl - Steel	■	04,95
TCMT 16T304-PF ER300	Stahl - Steel	■	06,95
TCMT 16T308-MP ER320	Stahl - Steel	■	06,95
WNMG 080408-FP ER300	Stahl - Steel	■	07,55
WNMG 080408-MP ER320	Stahl - Steel	■	07,55
WNMG 080408-RP ER335	Stahl - Steel	■	07,55
WNMG 080412-RP ER335	Stahl - Steel	■	07,55

Bezeichnung Geometrie Bearbeitung / Geometry processing application  
 FP= Feinbearbeitung schlichten Stahl / finishing steel  
 MP= Mittlere Bearbeitung Stahl, Edelstahl / medium steel, stainless steel  
 RP= Schrupp Bearbeitung Stahl, Edelstahl / roughing steel, stainless steel

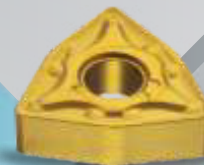



# P-SYSTEM KLEMMHALTER

## TURNING TOOL HOLDERS

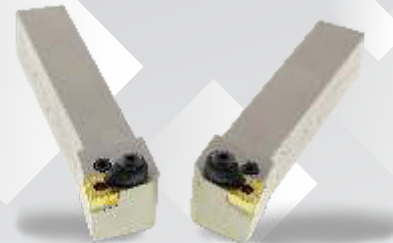

Artikel Nr. Ordering Code	Lager Stock		Dimension (mm) Dimension (mm)				Ersatzteile Spare parts							Preis € Price €			
	R	L	h/h1	b	L	II	f	WP Insert	U-Platte Shim	Kniehebel Lever	K-Schraube Lever screw	Feder f. U-Platte Shim spring	Spannpratze Clamp	Klemmschraube Clamp screw			
PCLNR/L 95°																	
1616 H12	■	■	16	16	100	26	20										57,00
2020 K12C	■	■	20	20	125	30	25	CN..	U	H	S	R					58,00
2525 M12C	■	■	25	25	150	30	32	1204	112150	023441	023421	023461	7830001	7830002			59,00
3225 P12C	■	■	32	25	170	30	32										67,00
3232 P12C	■	■	32	32	170	30	40										67,00
2525 M16C	■	■	25	25	150	33	32										61,00
3225 P16C	■	■	32	25	170	33	32	CN..	U	H	S	R					70,00
3232 P16C	■	■	32	32	170	33	40	1606	000152	000840	028430	025464	7485865	7485860			70,00
3225 P19C	■	■	32	25	170	38	32										79,00
3232 P19C	■	■	32	32	170	38	40	CN..	U	H	S	R					88,00
4040 R19C	■	■	40	40	200	38	50	1906	123151	033442	033422	033462	7485865	7485860			118,00
4040 R25C	■	■	40	40	200	47	50										129,00
5050 S25C	■	■	50	50	250	47	60	CN..	U	H	S	R					171,00
								2509	002540	038444	038427	038465	7485865	7485860			

■ in 4-6 Wochen/in 4-6 weeks

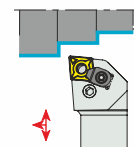
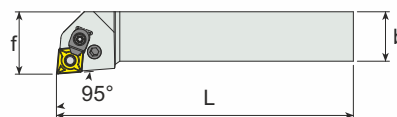

# P-SYSTEM KLEMMHALTER

## TURNING TOOL HOLDERS

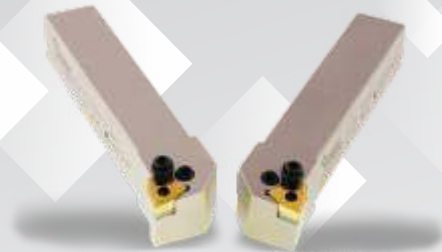

Artikel Nr. Ordering Code	Lager Stock		Dimension (mm) Dimension (mm)				Ersatzteile Spare parts							Preis € Price €		
	R	L	h/h1	b	L	ll	f	WP Insert	U-Platte Shim	Kniehebel Lever	K-Schraube Lever screw	Feder f. U-Platte Shim spring	Spannpratze Clamp	Klemmschraube Clamp screw		
PWLNRL 95°																
1616 H06	■	■	16	16	100	20	20	WN..	WNMG	H	S	R	-	-		57,00
2020 K06C	■	■	20	20	125	25	25	0604	0604	018440	018421	018463	7830001	7830002		58,00
2525 M06C	■	■	25	25	150	25	32									59,00
2020 M08C	■	■	20	20	125	25	25									58,00
2525 M08C	■	■	25	25	150	25	32	WN..	7853519	H	S	R	785865	7485860		59,00
3225 P08C	■	■	32	25	170	25	32	0804		023441	023421	023461				67,00
3232 P08C	■	■	32	32	170	25	40									67,00

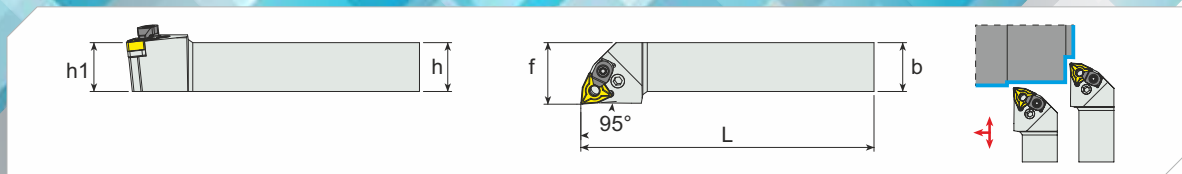

# SCHAFTFRÄSER END MILLS



Artikel Nr. Ordering Code	Lager Stock	Dimension (mm) Dimension (mm)						Wendeplatte Cutting insert	Ersatzteile Spare parts		Preis € Price €
		D	Z	d	L	l	a		Schraube/Screw	Schlüssel/Key	
SF9011D16W16L73Z02H	■	16	2	16	73	20	11	R390-11T3..	SR11-M2,5x6 2,40 €	TORX X-PLUS T8 3,90 €	99,00
SF9011D16W16L95Z02H	■	16	2	16	95	20	11				99,00
SF9011D16A16L110Z02H	■	16	2	16	110	25	11				109,00
SF9011D16W16L145Z02H	■	16	2	16	145	25	11				119,00
SF9011D20B20L110Z03H	■	20	3	20	110	25	11				119,00
SF9011D20A20L110Z02H	■	20	2	20	110	25	11				115,00
SF9011D20A20L170Z03H	■	20	3	20	170	25	11				129,00
SF9011D20A20L170Z02H	■	20	2	20	170	25	11				125,00
SF9011D25A25L170Z03H	■	25	3	25	170	32	11				139,00
SF9011D25B25L88Z03H	■	25	3	25	88	32	11				125,00
SF9011D25A25L170Z04H	■	25	4	25	170	32	11	145,00			
SF9011D32B32L100Z03H	■	32	3	32	100	40	11	149,00			

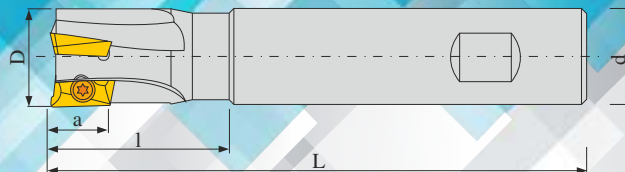

90°

# SCHAFTFRÄSER END MILLS



Artikel Nr. Ordering Code	Lager Stock	Dimension (mm) Dimension (mm)						Wendeplatte Cutting insert	Ersatzteile Spare parts		Preis € Price €
		D	Z	d	L	l	a		Schraube/Screw	Schlüssel/Key	
SF9017D25A25L170Z02H	■	25	2	25	170	45	17	R390-1704..	SR17-M3,5x9 2,40 €	TORX X-PLUS T15 3,90 €	139,00
SF9017D25A25L210Z02H	■	25	2	25	210	45	17				199,00
SF9017D32A32L170Z03H	■	32	3	32	170	45	17				167,00
SF9017D32B32L100Z03H	■	32	3	32	100	45	17				149,00

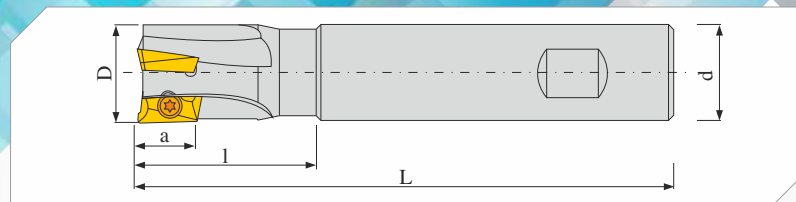

# MESSERKÖPFE FACE MILLING



Artikel Nr.  
Ordering Code

Lager  
Stock

Dimension (mm) Dimension (mm)					
D	Z	d	L	a	
40	4	16	40	11	■
40	5	16	40	11	■
50	6	22	40	11	■
63	6	22	40	11	■
63	8	22	40	11	■
40	4	16	40	17	■
50	4	22	40	17	■
50	5	22	40	17	■
63	5	22	40	17	■
80	6	27	50	17	■
100	7	32	50	17	■

Wendeplatte  
Cutting insert



Ersatzteile  
Spare parts



Preis €  
Price €

MK9011D40A16L40Z04H
MK9011D40A16L40Z05H
MK9011D50A22L40Z06H
MK9011D63A22L40Z06H
MK9011D63A22L40Z08H
MK9017D40A16L40Z04H
MK9017D50A22L40Z04H
MK9017D50A22L40Z05H
MK9017D63A22L40Z05H
MK9017D80A27L50Z06H
MK9017D100A32L50Z07H

R390-11T3..

SR11-M2,5x6  
2,40 €

TORX X-PLUS  
T8  
3,90 €

119,00  
129,00  
149,00  
169,00  
179,00

R390-1704..

SR17-M3,5x9  
2,40 €

TORX X-PLUS  
T15  
3,90 €

125,00  
139,00  
149,00  
159,00  
209,00  
219,00



90°

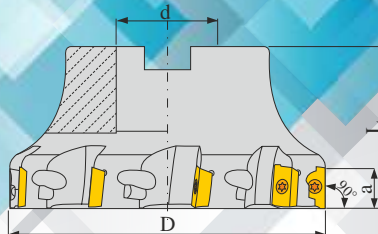

# SCHAFTFRÄSER END MILLS



Artikel Nr. Ordering Code	Lager Stock	Dimension (mm) Dimension (mm)						Wendeplatte Cutting insert	Ersatzteile Spare parts		Preis € Price €		
		D	Z	d	L	l	a		Schraube/Screw	Schlüssel/k			
SF90AP06D12C10L130Z02H	■	12	2	10	130		10	APMT 0602..	TORX X-PLUS T7 2,40 €	119,00			
SF90AP06D13C10L131Z02H	■	13	2	10	131		10			119,00			
SF90AP10D16W16L100Z02H	■	16	2	16	100	38	10	APKT 1003..	SR10-M2,5x6 2,40 €	99,00			
SF90AP10D16W16L150Z02H	■	16	2	16	150	40	10			115,00			
SF90AP10D20W20L100Z03H	■	20	3	20	100	30	10			99,00			
SF90AP10D20W20L150Z03H	■	20	3	20	150	38	10			115,00			
SF90AP10D25W25L150Z03H	■	25	3	25	150	50	10			125,00			
SF90AP10D25W25L100Z03H	■	25	3	25	100	38	10			109,00			
SF90AP10D25W25L100Z04H	■	25	4	25	100	25	10			119,00			
SF90AP10D25W25L150Z04H	■	25	4	25	150	40	10			130,00			
SF90AP10D32W32L100Z04H	■	32	4	32	100	35	10			125,00			
SF90AP10D32W32L150Z04H	■	32	4	32	150	35	10			135,00			
SF90AP16D25W25L150Z02H	■	25	2	25	150	50	16			APKT 1604..	SR16-M3,5x11 2,40 €	TORX X-PLUS T15 3,90 €	125,00



90°

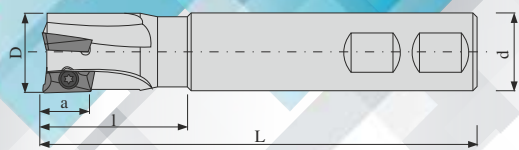

# MESSERKÖPFE FACE MILLING



Artikel Nr.  
Ordering Code

Lager  
Stock

Dimension (mm)  
Dimension (mm)

Wendeplatte  
Cutting insert

Ersatzteile  
Spare parts  
Schraube/Screw  
Schlüssel/Key

Preis €  
Price €

MK90AP10D40d16Z05H
MK90AP10D50d22Z06H
MK90AP10D50d22Z07H
MK90AP10D63d22Z07H
MK90AP10D80d27Z08H
MK90AP16D50d22Z05H
MK90AP16D63d22Z06H
MK90AP16D80d27Z07H

- 
- 
- 
- 
- 
- 
- 
- 

D	Z	d	L	a
40	5	16	40	10
50	6	22	40	10
50	7	22	40	10
63	7	22	40	10
80	8	27	27	10
50	5	22	40	16
63	6	22	40	16
80	7	27	50	16

APKT 1003..

AP..1604..

SR10-M2,5x6  
2,40 €

TORX X-PLUS  
T8  
3,90 €

SR16M3,5x11  
2,40 €

TORX X-PLUS  
T15  
3,90 €

115,00

129,00

139,00

149,00

169,00

129,00

139,00

169,00

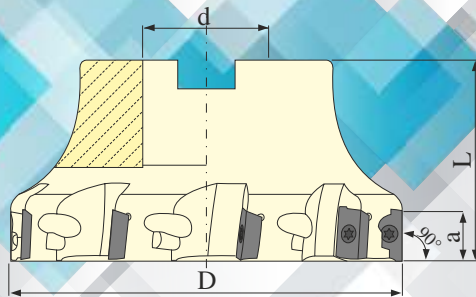

# PLANFRÄSER FACE MILLS



Artikel Nr. Ordering Code
PF245D50d22L40Z04H
PF245D63d22L40Z05H
PF245D80d27L50Z06H
PF245D80d27L50Z08H
PF245D100d32L50Z07H
PF245D125d40L63Z08H



Lager Stock	Dimension (mm) Dimension (mm)				
	D	Z	d	L	a
■	50	4	22	40	12
■	63	5	22	40	12
■	80	6	27	50	12
■	80	8	27	50	12
■	100	7	32	50	12
■	125	8	40	63	12

Wendeplatte  
Cutting insert



SE.. 12T3..  
R245-12T3..

Ersatzteile  
Spare parts

Schraube/Screw  Schlüssel/Key 

SR12-M3,5X11  
2,40 €

TORX X-PLUS  
T15  
3,90 €

Preis € Price €
139,00
159,00
179,00
209,00
219,00
299,00

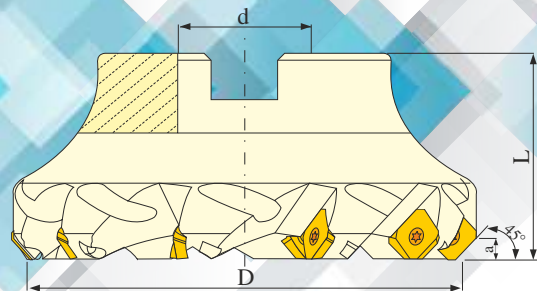



# SCHAFTFRÄSER END MILLS

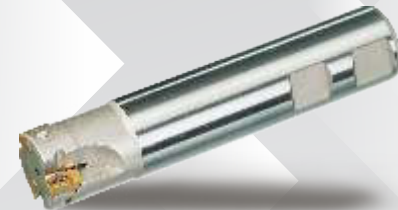

Artikel Nr.  
Ordering Code

Lager  
Stock

Dimension (mm) Dimension (mm)						
D	Z	d	L	l	a	
16	3	16	150	35	10	■
16	3	16	100	35	10	■
20	3	20	150	35	10	■
20	3	20	100	35	10	■
20	2	20	150	35	12	■
20	2	20	100	35	12	■
25	3	25	150	30	12	■
25	3	25	100	30	12	■
32	3	32	32	30	12	■

Wendeplatte  
Cutting insert



Ersatzteile  
Spare parts



Preis €  
Price €

SF90XO10D16d16L150Z03H
SF90XO10D16d16L100Z03H
SF90XO10D20d20L150Z03H
SF90XO10D20d20L100Z03H
SF90XO12D20d20L150Z02H
SF90XO12D20d20L100Z02H
SF90XO12D25d25L150Z03H
SF90XO12D25d25L100Z03H
SF90XO12D32d32L150Z03H

XO.. 10T3..
XO.. 1204..

Sr10 M3,5X6 2,40 €	TORX X-PLUS T10 3,90 €
SR12-M3,5x9 2,40 €	TORX X-PLUS T10 3,90 €

119,00
99,00
129,00
119,00
129,00
129,00
119,00
139,00
129,00
149,00

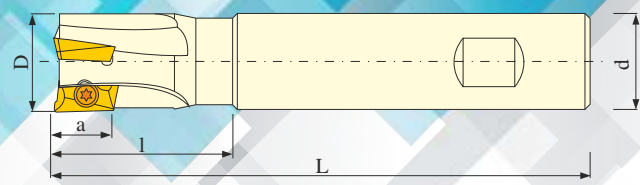

# MESSERKÖPFE FACE MILLING



Artikel Nr.  
Ordering Code

- MK90XO12D40d16Z05H
- MK90XO12D50d22Z05H
- MK90XO12D63d22Z06H

Lager  
Stock

- 
- 
- 

Dimension (mm) Dimension (mm)				
D	Z	d	L	a
40	5	16	40	12
50	5	22	40	12
63	6	22	40	12

Wendeplatte  
Cutting insert



XO.. 1204..

Ersatzteile  
Spare parts



Schraube/Screw  
Schlüssel/Key

SR12M3,5x7  
2,40 €

TORX X-PLUS  
T10  
3,90 €

Preis €  
Price €

119,00

135,00

149,00



90°

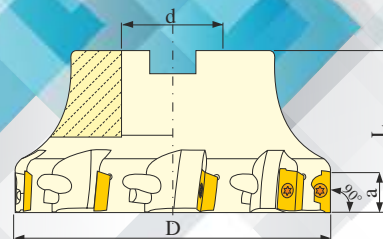

# HM BOHRSTANGE

## SOLID CARBIDE BORING BAR



Artikel Nr. Ordering Code	Lager Stock	Dimension (mm) Dimension (mm)					Wendeplatte Cutting insert	Ersatzteile Spare parts		Preis € Price €
		D	h	L	I	Dmin		Schraube/Screw	Schlüssel/Key	
E06K SCLCL/R 06-R	■	6	7	125	11	9,3	CCMT0602..	SR11-M2,5x6 2,40 €	TORX X-PLUS T8 - 3,90 €	140,00
E08K SCLCL/R 06-R	■	8	7,5	125	11	11				140,00
E10M SCLCL/R 06-R	■	10	9,5	150	13	13				160,00
E12Q SCLCL/R 09-R	■	12	11	180	16	16	CCMT09T3..	SR11-M3,5x10 2,40 €	TORX X-PLUS T15 - 3,90 €	190,00
E16R SCLCL/R 09-R	■	16	15	200	20	21				295,00
E20S SCLCL/R 09-R	■	20	19	250	24	25				455,00
E08K SDUCL/R 07-R	■	8	7,5	125	11	12	DCMT0702..	SR11-M2,5x6 2,40 €	TORX X-PLUS T8 - 3,90 €	140,00
E10M SDUCL/R 07-R	■	10	9,5	150	13	13,6				160,00
E12Q SDUCL/R 07-R	■	12	11	180	16	17				190,00
E16R SDUCL/R 11-R	■	16	15	200	20	21	DCMT11T3..	SR11-M3,5x10 2,40 €	TORX X-PLUS T15 - 3,90 €	295,00
E20S SDUCL/R 11-R	■	20	19	250	24	25				455,00



# ERAX-FIX

SPANNAUFNAHME ZYLINDRISCHER BOHRSTANGEN  
SLEEVES FOR CORRECT MOUNTING



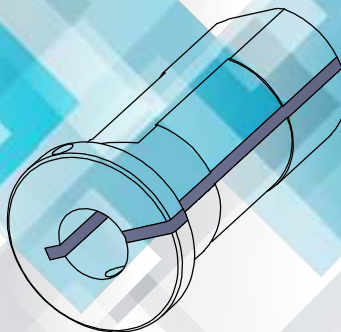

Artikel Nr. Ordering Code	Lager Stock	Dimension (mm) Dimension (mm)				Preis € Price €
		dmt	L1	l2	Dmm	
ADPT 132L 2506-B	■	6	6	62	25	75,00
ADPT 132L 2508-B	■	8	6	62	25	75,00
ADPT 132L 2510-B	■	10	6	62	25	75,00
ADPT 132L 2512-B	■	12	6	62	25	75,00
ADPT 132L 2516-B	■	16	6	62	25	75,00
ADPT 132L 3220-B	■	20	7	63	32	75,00



# VOLLBOHRER UDRILL



ØD (mm)	Lager Stock	ERAX TOOLS POWER DRILL Wendeplatten-Vollbohrer				Wendeplatte Cutting insert 	Ersatzteile Spare parts		13200	13300	13400	13500
		13200	13300	13400	13500		Schraube/Screw	Schlüssel/Key	12 (mm)	12 (mm)	12 (mm)	12 (mm)
		2xD	3xD	4xD	5xD							
16	■	147 €	157 €	259 €	275 €	WCM.0302 08	SR11-M2,5x7 2,40 €	TORX X-PLUS T8 3,90 €	54	70	86	100
16,5	■	147 €	157 €	259 €	275 €				54	70	86	100
17	■	147 €	157 €	259 €	275 €				56	73	90	105
17,5	■	147 €	157 €	259 €	275 €				56	73	90	105
18	■	147 €	157 €	259 €	275 €				58	76	94	111
18,5	■	147 €	157 €	259 €	275 €				58	76	94	111
19	■	147 €	157 €	259 €	275 €				60	79	98	119
19,5	■	147 €	157 €	259 €	275 €				60	79	98	119
20	■	157 €	163 €	270 €	286 €				62	82	102	120
20,5	■	157 €	163 €	270 €	286 €				62	82	102	120
21	■	157 €	163 €	270 €	286 €	WCM.0402 08			64	85	106	124
21,5	■	157 €	163 €	270 €	286 €				64	85	106	124
22	■	157 €	163 €	270 €	286 €				64	85	106	124
									66	88	110	129

■ in 4-6 Wochen/in 4-6 weeks

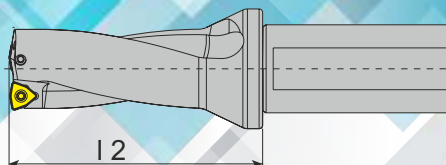

# VOLLBOHRER UDRILL



ØD (mm)	Lager Stock	ERAX TOOLS POWER DRILL Wendeplatten-Vollbohrer				Wendeplatte Cutting insert	Ersatzteile Spare parts	13200	13300	13400	13500
		13200	13300	13400	13500						
		2xD	3xD	4xD	5xD						
22,5	■	157 €	163 €	270 €	286 €	WCM.0402 08	SR11-M2,5x7 2,40 €	12 (mm)	12 (mm)	12 (mm)	12 (mm)
23	■	157 €	163 €	270 €	286 €			71	94	117	129
23,5	■	157 €	163 €	270 €	286 €	WCM.0503 08	SR11-M3x8 2,40 €	74	98	122	135
24	■	163 €	169 €	282 €	297 €			74	98	122	140
24,5	■	163 €	169 €	282 €	297 €			77	102	127	140
25	■	163 €	169 €	282 €	297 €			77	102	127	144
25,5	■	163 €	169 €	282 €	297 €			79	105	131	144
26	■	163 €	169 €	282 €	297 €			79	105	131	149
26,5	■	163 €	169 €	282 €	297 €			81	108	135	149
27	■	163 €	169 €	282 €	297 €			81	108	135	155
27,5	■	163 €	169 €	282 €	297 €			84	112	140	155
28	■	163 €	169 €	282 €	297 €			84	112	140	160
28,5	■	163 €	169 €	282 €	297 €	86	115	144	160		

■ in 4-6 Wochen/in 4-6 weeks

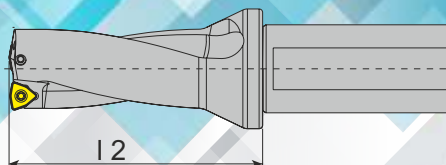

# VOLLBOHRER UDRILL



ØD (mm)	Lager Stock	ERAX TOOLS POWER DRILL Wendeplatten-Vollbohrer				Wendeplatte Cutting insert	Ersatzteile Spare parts		13200	13300	13400	13500
		13200	13300	13400	13500		Schraube/Screw	Schlüssel/Key				
		2xD	3xD	4xD	5xD		12 (mm)	12 (mm)				
29	■	174 €	179 €	293 €	305 €	WCM.0503 08	SR11-M3x8 2,40 €	T8 3,90 €	80	109	144	167
29,5	■	174 €	179 €	293 €	305 €				80	109	146	167
30	■	174 €	179 €	293 €	305 €				87	117	147	177
31	■	174 €	179 €	293 €	305 €				89	120	151	177
32	■	174 €	179 €	293 €	305 €				91	123	155	180
33	■	174 €	179 €	293 €	305 €				93	126	159	185
34	■	174 €	179 €	293 €	305 €				95	129	163	190
35	■	174 €	179 €	293 €	305 €				97	132	167	195
36	■	174 €	179 €	293 €	305 €				99	135	171	200
37	■	174 €	179 €	293 €	305 €				101	138	175	205
38	■	174 €	179 €	293 €	305 €	WCM.06T3 08	SR11-M3.5x 10 2,40 €	TORX X-PLUS T15 3,90 €	103	141	179	210
39	■	174 €	179 €	293 €	305 €				105	144	183	215
40	■	174 €	179 €	293 €	305 €				107	147	187	220

■ in 4-6 Wochen/in 4-6 weeks

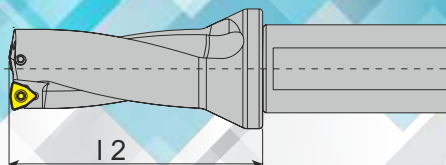

# FASENFRÄSER

## CHAMFERING

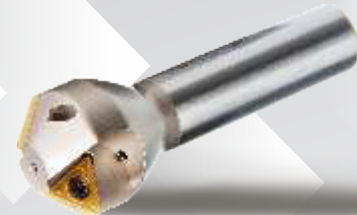

Artikel Nr.  
Ordering Code

Lager  
Stock

Dimension (mm)  
Dimension (mm)

Wendeplatte  
Cutting insert

Ersatzteile  
Spare parts

Preis €  
Price €

FF45TC11D4x15W16L100Z01H	■
FF45TC16D10x31W16L100Z02H	■
FF45TC16D30x45W20L100Z02H	■
FF45TC16D14x35W20L100Z02H	■
FF45TC16D5x35W16L100Z01H	■

$\alpha$	D	D <sub>max</sub>	D1	L	L1	Z
45°	4	15	16	100	30	1
45°	10	31	16	100	30	2
45°	30	45	20	100	30	2
45°	14	35	20	100	30	2
45°	5	35	16	100	30	1



TCMT 1103..  
  
TCMT 16T3..



SR16M3,5x11  
2,40 €  
  
TORX X-PLUS  
T15  
3,90 €

TCMT 1103..  
  
62,00  
62,00  
62,00  
62,00



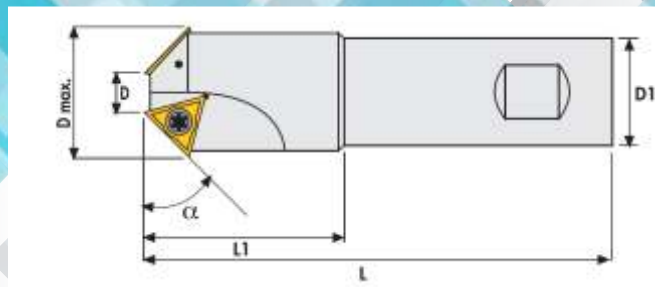

45°





# STECHSCHWERT EXT. GROOVING



Artikel Nr. Ordering Code	Lager Stock	Dimension (mm) Dimension (mm)					Wendeplatte Cutting insert	Ersatzteile Spare parts Schlüssel/Key	Preis € Price €
		B	W	L	h	D <sub>MAX</sub>			
SN 151 26-3	■	26	3	110	21,3	39	N151.. 	SN151	56,00
SN 151 26-4	■	26	4	110	21,3	39			56,00
SN 151 32-3	■	32	3	150	24,8	39	N123.. 	SN123	56,00
SN 151 32-4	■	32	4	150	24,8	39			56,00
SN 151 32-5	■	32	5	110	21,3	39			56,00
SN 123 32-3	■	32	3	110	21,3	39			56,00
SN 123 32-4	■	32	4	150	24,8	39			56,00

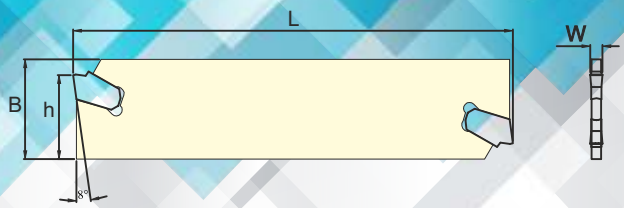

# STECHSCHWERT

## EXT. GROOVING



Artikel Nr.  
Ordering Code

SGTN 26-2  
SGTN 26-3  
SGTN 26-4  
SGTN 26-5  
SGTN 32-2  
SGTN 32-3  
SGTN 32-4

Lager  
Stock

- 
- 
- 
- 
- 
- 
- 

Dimension (mm)  
Dimension (mm)

B	W	L	h	D <sub>MAX</sub>
26	2	110	21,3	39
26	3	110	21,3	39
26	4	110	21,3	39
26	5	110	21,3	39
32	2	150	24,8	39
32	3	150	24,8	39
32	4	150	24,8	39

Wendeplatte  
Cutting insert



Preis €  
Price €

GTN..  
56,00  
56,00  
56,00  
56,00  
56,00  
56,00  
56,00

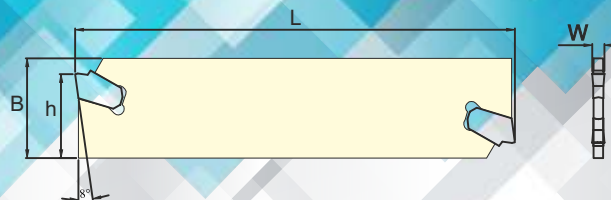

# SPANNBLOCK FÜR STECHWERFE BLOCKS

FOR PARTING AND DEEP GROOVING BLADES



Artikel Nr. Ordering Code	Lager Stock	Dimension (mm) Dimension (mm)									Preis € Price €
		H	H1	H2	H3	H4	B	L1	L2	L3	
SB 1616-26	■	25,9	21,9	16	12	41	5,5	110	16	35,5	70,00
SB 2020-26	■	25,9	21,9	20	8	41	5,5	110	20	39,5	70,00
SB 2525-26	■	31,9	24,9	20	13	49	5,5	110	20	39,5	70,00
SB 2020-32	■	26	21,9	25	6	44	5,5	110	25	44,5	70,00
SB 2525-32	■	32	24,9	25	10	51	5,5	110	25	44,5	70,00

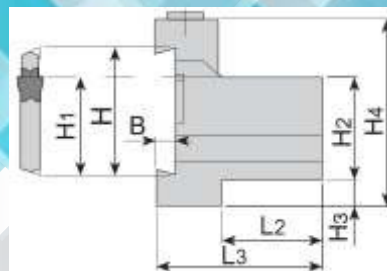

# HOCHVORSCHUBSCHAFTFRÄSER

## HIGH FEED MILLING TOOLS



Artikel Nr. Ordering Code	Lager Stock	Dimension (mm) Dimension (mm)							Wendeplatte Cutting insert	Ersatzteile Spare parts	Preis € Price €	
		D	Z	d	L	l	a	p	Schraube/Screw	Schlüssel/key		
SF90HF06D16W16L120Z02H	■	16	2	16	120	40	8	130	 HFMP0603	 SR11-M2,6X7 2,40 €	 TORX X-PLUS T8 3,90 €	119,00
SF90HF06D20W20L150Z03H	■	20	3	20	150	40	8	140				129,00
SF90HF06D25W25L150Z04H	■	25	4	36	150	40	8	150				145,00
SF90HF06D32W32L150Z05H	■	32	5	32	150	40	8	150				149,00

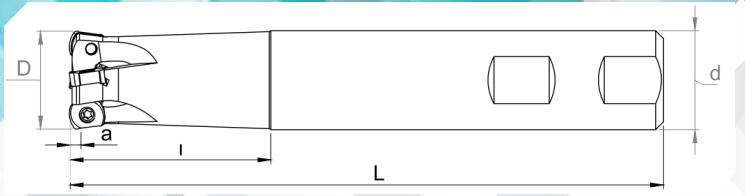
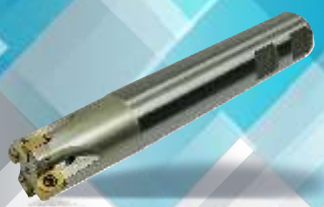

# HOCHVORSCHUBSCHAFTFRÄSER

## HIGH FEED MILLING TOOLS



Artikel Nr.  
Ordering Code

Lager  
Stock

Dimension (mm) Dimension (mm)				
D	Z	d	L	ap
40	6	16	40	1
50	7	22	40	1
63	8	22	40	1

Wendeplatte  
Cutting insert



HFMP0603  
CAM  
R 2.0

Ersatzteile  
Spare parts



Schraube/Screw  
Schlüssel/Key

SR11-M2,6X7  
2,40 €

TORX X-PLUS  
T8  
3,90 €

Preis €  
Price €

MK90HF06D40d16L40Z06H	■
MK90HF06D50d22L40Z07H	■
MK90HF06D63d22L40Z08H	■

149,00
169,00
179,00

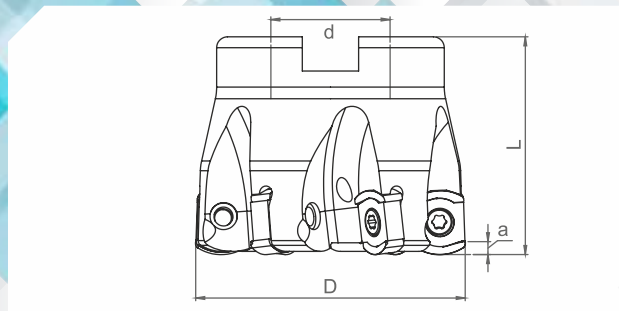

# HOCHVORSCHUBSCHAFTFRÄSER

## HIGH FEED MILLING TOOLS

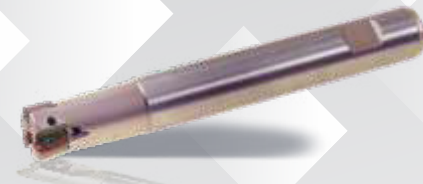



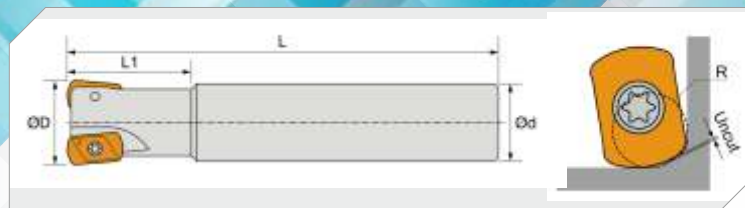

Artikel Nr. Ordering Code	Lager Stock	Dimension (mm) Dimension (mm)							Wendeplatte Cutting insert	Ersatzteile Spare parts		Preis € Price €
		D	Z	d	L	l	a	p		Schraube/Screw	Schlüssel/Key	
SF90LN03D16W16L150Z02H	■	16	2	16	150	40	8	130	 LNMX0303 	SR11-M2,6X7	TORX X-PLUS T8	119,00
SF90LN03D20W20L150Z03H	■	20	3	20	150	40	8	130		2,40 €	3,90 €	129,00
SF90LN03D25W25L150Z04H	■	25	4	25	150	40	8	140				145,00



# HOCHVORSCHUBSCHAFTFRÄSER

## HIGH FEED MILLING TOOLS



Artikel Nr. Ordering Code	Lager Stock	Dimension (mm) Dimension (mm)					Wendeplatte Cutting insert 	Ersatzteile Spare parts		Preis € Price €
		D	Z	d	L	ap		Schraube/Screw 	Schlüssel/Key 	
MK90LN03D40d16L40Z05H	■	40	6	16	40	1	LMNX0303 	SR11-M2,6X7 2,40 €	TORX X-PLUS T8 3,90 €	149,00
MK90LN03D50d22L40Z07H	■	50	7	22	40	1		169,00		
MK90LN03D63d22L40Z09H	■	63	8	22	40	1		179,00		

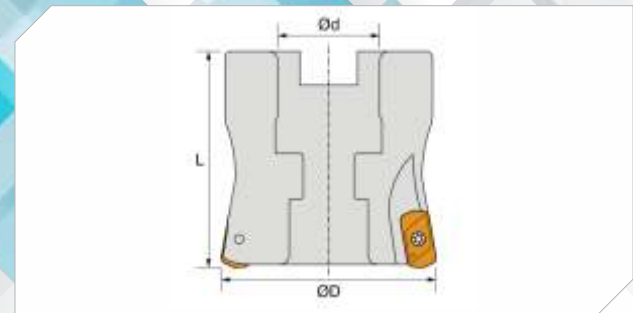

# PLANFRÄSER

## FACE MILLS



Artikel Nr. Ordering Code	Lager Stock	Dimension (mm) Dimension (mm)					Wendeplatte Cutting insert	Ersatzteile Spare parts		Preis € Price €
		D	Z	d	L	a		Schraube/Screw	Schlüssel/Key	
MK90XN08D50d22L40Z04H	■	50	4	22	40	8	XNMX0806 08	SR12-M3,5X11 2,40 €	TORX X-PLUS T15 3,90 €	139,00
MK90XN08D63d22L40Z05H	■	63	5	22	40	8				159,00
MK90XN08D80d27L50Z07H	■	80	6	27	50	8				179,00
MK90XN08D100d32L50Z08H	■	100	7	32	50	8				209,00
MK90XN08D125d40L63Z11H	■	125	8	40	63	8				219,00

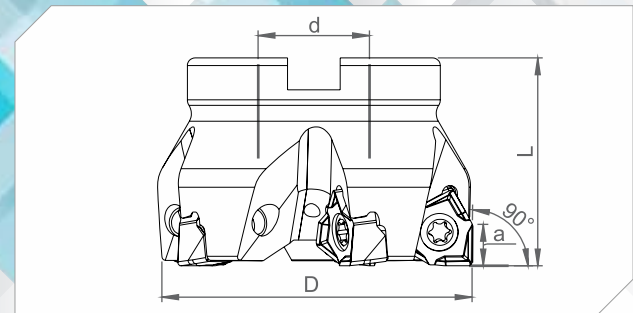



# PLANFRÄSER 75°

## FACE MILLING TOOLS 75°



Artikel Nr.  
Ordering Code

AFR75CN12D63A22Z04H

AFR75CN12D100A32Z06H

Lager  
Stock

- 
- 
- 

Dimension (mm)  
Dimension (mm)

D	Z	d	L	ap
63	4	22	40	12
100	6	32	50	12

Wendeplatte  
Cutting insert



CNMG1204

Ersatzteile  
Spare parts



S9216 NL46-M6 8,80 €	7485865 14,80 €	7485860 2,80 €
----------------------------	--------------------	-------------------

Preis €  
Price €

385,00  
645,00

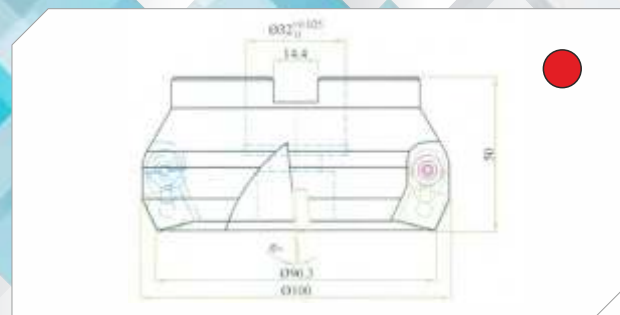



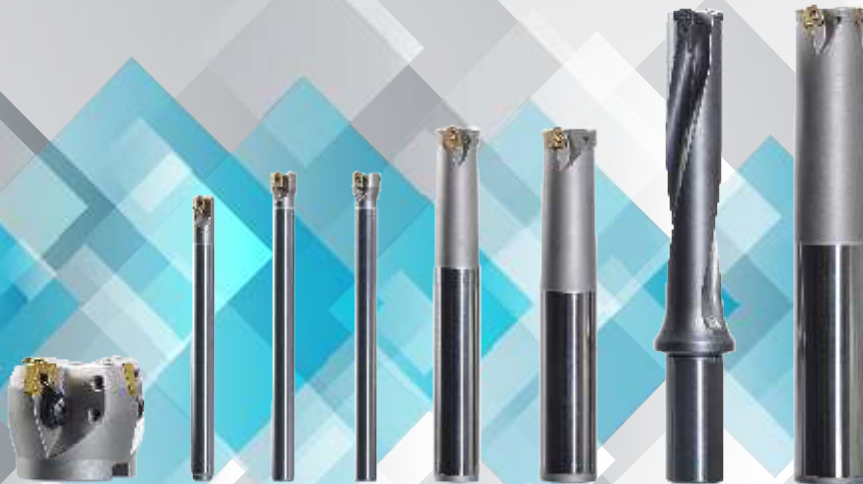

# HOCHVORSCHUBSCHAFTFRÄSER

HIGH FEED MILLING TOOLS



# HOCHVORSCHUBSCHAFTFRÄSER

HIGH FEED MILLING TOOLS



**HOCHVORSCHUBSCHAFTFRÄSER**  
HIGH FEED MILLING TOOLS



NOTIZEN  
NOTES



A large white rectangular area with horizontal dashed lines, intended for taking notes.



IHRE HANDELSPARTNER:

